

Delivery of sustainable supply of non-food biomass to support a
“resource-efficient” Bioeconomy in Europe

S2Biom Project Grant Agreement n°608622

D4.2

Draft structure of the S2BIOM General User Interface (GUI)

Version: 0.2

6.04.2017



About S2Biom project

The S2Biom project - Delivery of sustainable supply of non-food biomass to support a “resource-efficient” Bioeconomy in Europe - supports the sustainable delivery of non-food biomass feedstock at local, regional and pan European level through developing strategies, and roadmaps that will be informed by a “computerized and easy to use” toolset (and respective databases) with updated harmonized datasets at local, regional, national and pan European level for EU28, Western Balkans, Moldova, Turkey and Ukraine. Further information about the project and the partners involved are available under www.s2biom.eu.

Project coordinator



Scientific coordinator



Project partners



About this document

It has been prepared by:

Due date of deliverable:	PM 17
Actual submission date:	2015-06-15
Start date of project:	2013-01-09
Duration:	36 months

Work package	4
Task	Central database
Lead contractor for this deliverable	DLO-Alterra
Editor	Berien Elbersen
Authors	Berien Elbersen (DLO [Alterra]) Igor Staritsky (DLO) Hugo de Groot (DLO)
Quality reviewer	

Dissemination Level		
PU	Public	X
PP	Restricted to other programme participants (including the Commission Services)	
RE	Restricted to a group specified by the consortium (including the Commission Services):	
CO	Confidential, only for members of the consortium (including the Commission Services)	

Version	Date	Author(s)	Reason for modification	Status
0.1	1/07/2015	DLO	This report will be up-dated later in project as GUI is further developed through the project with input from other WPs	Final
0.2	6/04/2017	DLO	Minor editorial corrections concerning statements referring to the 7th Frame Programme and responsibility.	Final

This project entitled S2BIOM (Delivery of sustainable supply of non-food biomass to support a "resource-efficient" Bioeconomy in Europe) is co-funded by the European Union within the 7th Framework Programme. Grant Agreement n°608622.

The sole responsibility of this publication lies with the author. The European Union is not responsible for any use that may be made of the information contained therein

Editor contact details:

Dr. Berien Elbersen
Wageningen Environmental Research,
Team Earth Informatics
P.O.Box 47
6700 AA Wageningen
The Netherlands
+31 (0)317 481935 (phone)/+31 (0)653728652 (mobile)
berien.elbersen@wur.nl

Executive summary

This report explains the overall structure of the General User Interface of the S2BIOM tool box for as far developed in this stage of the project. The GUI should provide access to all S2BIOM tools, databases and reports developed in the project in an easy to use and straight forward way. It should provide access to data for which viewing and extraction functionalities will be presented to the users.....

Table of contents

Table of contents	4
List of Figures	Error! Bookmark not defined.
List of Tables	Error! Bookmark not defined.
1 Introduction	5
2 Data collection by issue.....	Error! Bookmark not defined.
2.1 <please provide a descriptive title of the data collection issue>	Error!
Bookmark not defined.	
2.1.1 Introduction	Error! Bookmark not defined.
2.1.2 Description of the questionnaire.....	Error! Bookmark not defined.
2.1.3 Participants	Error! Bookmark not defined.
2.1.4 Results	Error! Bookmark not defined.
2.1.5 Experiences	Error! Bookmark not defined.
3 Summary	Error! Bookmark not defined.

1 Introduction

At this stage all project partners have access to a general user interface (GUI) which enables them to access and use, test and further elaborate the tools and access and populate the conversion and pre-treatment technologies and logistical components databases developed until now. An overview of what is integrated into the GUI is presented in this report. It provides a good overview of the progress made and also of the whole integrated toolset the project is going to deliver.

The GUI is a web-based platform enabling access to data and assessment tools for full chain design and evaluation of biomass delivery chains at regional and wider national and pan-European level . It provides viewing, download and further spatial assessment facilities for several types of new data and knowledge collected and further generated in the S2BIOM project in the different WPs.

In this report first a full overview is given of the GUI as it is now. In Chapter 3 a description is given of the different components the GUI covers. In Chapter 4 a description is given of the technical implementation of the GUI.

2 Overall structure of the GUI

The overall structure of the GUI is presented below. The main items according to which the entrance to the S2BIOM tool box is organised are presented in this overview. When users enter the GUI they get this overview and underneath an explanation on for whom the tools box of S2BIOM is targeted and a general explanation of the S2BIOM project and a very short user guidance.

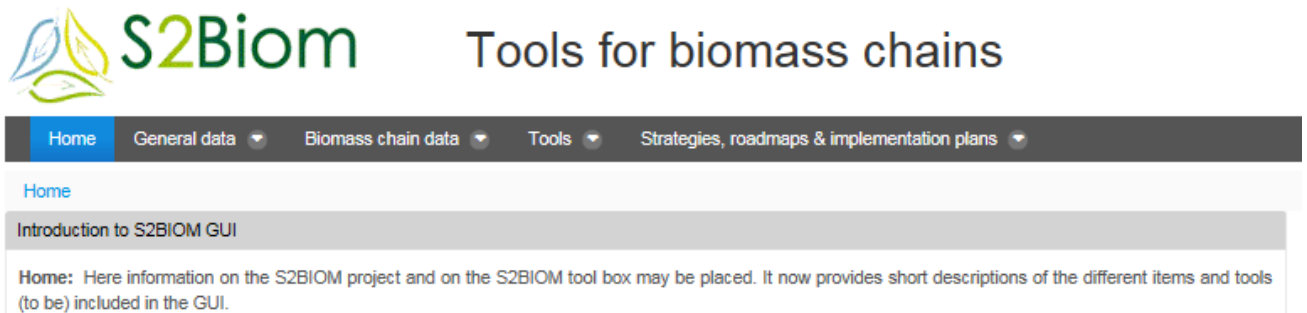

In the following the different entry items are further described to get a full overview how the GUI is organised over all data and knowledge generated in the project.

2.1 General data

General data: Under this item the following output will be included:

Scenarios (WP7): A description will be placed here of the central scenarios used in the project and the specific parameters determining the scenario in relation to e.g. sustainability, resource efficiency, policies, biomass demand, demographic developments, competition for biomass, oil price etc..

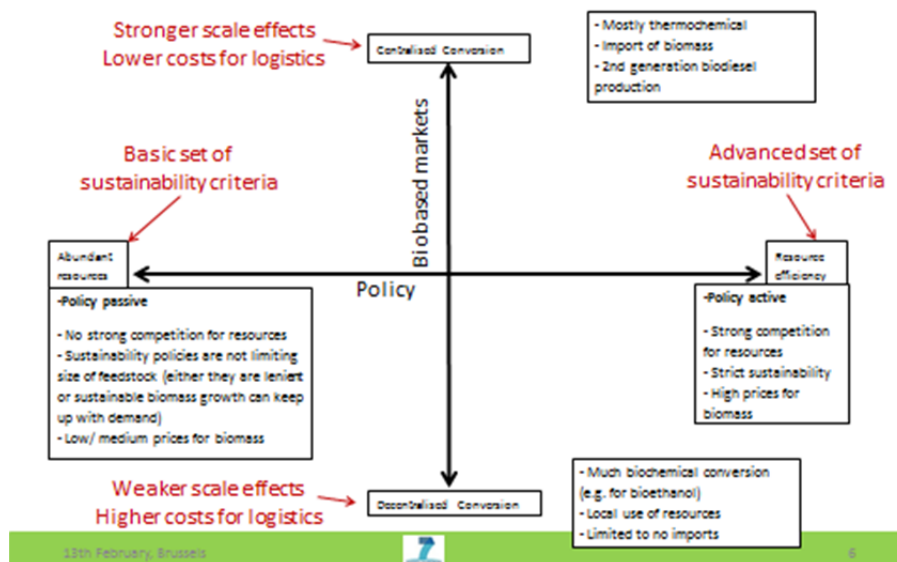

For more detailed information on the scenarios and how they are used a link will be placed here to the final deliverable explaining the scenarios in detail (D7.1).

Regulatory & financial framework (WP6): This is where the entry into the viewing tool will be for viewing all data on policies developed in WP6. Currently all data on regulations are collected through an excel database in WP6. These excel data have been loaded in a central access database. The data in the access database needs to be transferred to a new PostgreSQL 9.3 database, to make it available to be interactively displayed in the viewing and download tool accessible through the GUI.

In the viewing tool the data request can be taken from these different perspectives of biomass delivery chain positions. Access to the data can be through at least 16 different perspectives ranging from geographic, the 5 positions in the chain (from supply to end-use) and according to the 9 regulatory issues (from environment to innovation).

Biomass demand (WP7): Under this item access will be provided to the demand analysis results assessed in WP7 with the ReSolve model taking account of scenario specifications and specific EU and national targets for renewable energy production by 2020/2030. Results for this task are to be included around month 24.

2.2 Biomass chain data

Under the item 'Biomass chain data' access is provided to all data collected in the project in relation to the biomass cost-supply for different potentials in 2010, 2020 and 2030, on biomass conversion and pre-treatment technologies and logistical concepts and sustainability through the biomass delivery chain.



Biomass chains

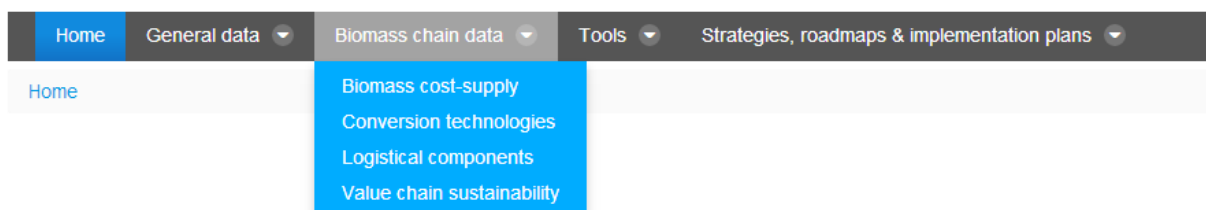

2.2.1 Biomass cost-supply (WP1)

Biomass cost-supply data generated in the project is to be viewed in the biomass cost supply tool which enables easy viewing and further analysis capabilities for data on biomass supply at different spatial resolution levels (Nuts 0, 1, 2, 3). At this moment this tool includes draft cost-supply data for 2010 and a baseline scenario situation in 2020 and 2030, but the cost-supply viewing tool and the underlying data are currently up-dated. The up-dated biomass cost-supply data will be added for European feedstock, but also for imports.

The cost-supply data are to be provided for 3 or more types of potentials and for 3 time periods:

scenario	year	year	year
Technical potential	2012	2020	2030
Base Potential	2012	2020	2030
User defined potential A	2012	2020	2030
User defined potential B	2012	2020	2030
User defined potential C	2012	2020	2030

For the user defined potentials; these are to be defined specifically per biomass type and sometimes there are only 2 for biomass A, while there could be 4 for biomass type B.

The cost supply data to be included will assume different technical, economic and sustainability requirements to be generated in WP1 based on specifications from other WPs, particularly WP5 on sustainability.

The tool also provides spatial zooming options to support users to obtain cost-supply information for their own interest area.

In the current up-date this tool will be further elaborated to enable viewing and also downloading data on cost supply making sub-selections in terms of specific price/cost ranges and a combination of biomass categories. In the last year of the project it is also foreseen that the tool facilitates viewing and downloading data from external sources, provided they comply with the project guidelines and can be fitted with the data structure of the tool.

2.2.2 Conversion technologies (WP2.1 & WP4.2)

This item in the GUI gives access to the database containing an extensive amount of characteristics on a large number of biomass conversion technologies collected in WP 2. Currently the access to this database is simple and provides more of a scrolling function through all records specified so far. In the near future a tool will be further developed to provide a systematic and visually attractive overview of the main technical, economic and GHG emission parameters of current and future pre-

treatment and conversion technologies through selections specified by the user. The data included in this database will also be the basic data feeding the Biomass Matching tool which is to be made accessible under the 'Tool' item in the GUI.

The conversion technology types included in this database can be classified as:

- Thermal conversion processes
- Chemical conversion processes
- Bio-chemical conversion processes
- (Biobased) products/building blocks

At the moment there are 42 conversion technologies stored inside the database, but this number is growing.

2.2.3 Logistical components (WP3.1 & WP4.2)

This item in the GUI gives access to the database on logistical components. It includes a long list of parameters for pre-treatment, storage and transport technologies that are needed to deliver biomass feedstock of a specified quality at the correct moment to a processing technology. In the current version of the database per conversion technologies parameters are specified on general properties (e.g. functionality, technology readiness and number of systems already in operation), technical properties, biomass input and output specifications and financial and economic properties. Particularly the biomass input and output properties information are crucial information for feeding the Biomass Matching tool which is to be made accessible under the 'Tool' item in the GUI.

At the moment there are 220 logistic components stored inside the database, but their number is still growing.

2.2.4 Value chain sustainability (WP5)

This item in the GUI gives access to the indicators and guidelines to be developed in WP5 for assessing the overall sustainability performance for bioeconomy value chains. This should cover both quantifiable sustainability indicators (e.g. assessment of total GHG emissions and mitigation, land use related impacts on water, air, soil) and also overall sustainability performance of a chain. In the absence of adequate quantitative variables, qualitative classification will be included. Currently these indicators have not been finalised; so under the current GUI they are not yet accessible.

The indicator and guideline framework developed in WP5 will also be used as input into the full chain assessment tools to be made accessible under the 'Tool' item in the GUI.

2.3 Full chain assessment tools

In this part of the GUI the more integrative assessment tools developed in the project are to be placed.

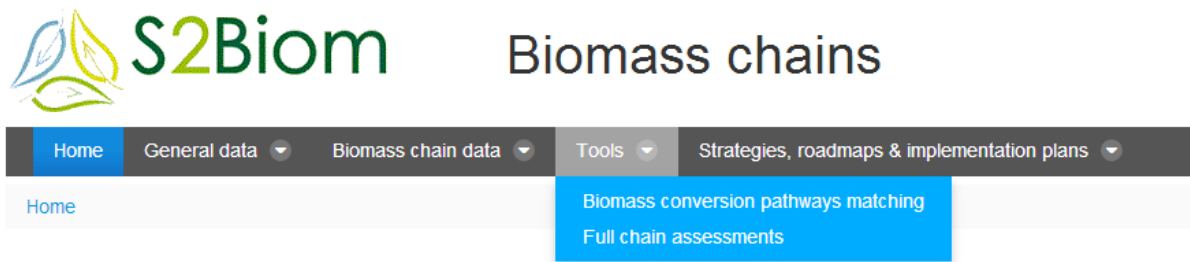

2.3.1 Biomass conversion pathways matching

This tool which is currently being developed and a first version expected to become accessible around Month 24 in the project. It provides support to users in finding the best match between a certain amount of biomass with specific characteristics as specified in the cost-supply database (WP 1) and the conversion (WP2) and/or logistical components and pre-treatment technologies.

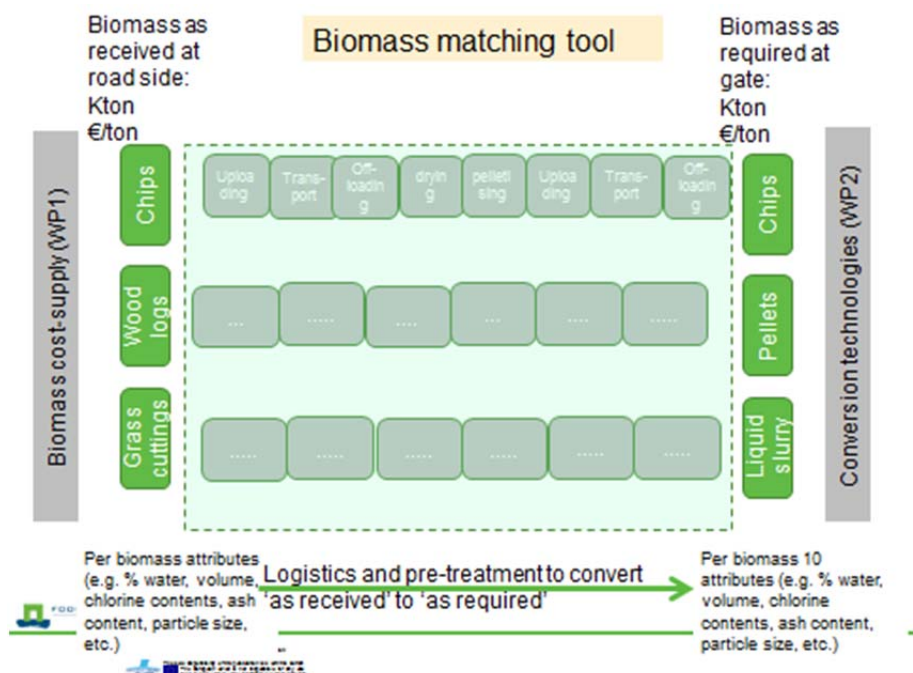

The tool will guide the user towards the optimal match by asking specific information and ruling out the less optimal solutions in a stepwise approach. 3) The user can obtain for every selected technology (including economy of scale) an overview of the main requirements for biomass feedstock in terms of quality parameters and minimum amount required and this will then be used by the tool to it can then provide information on which types of biomass in a certain region or country are suitable. The opposite is also planned to make possible; as the user can select a certain type of biomass and then the tool can provide feedback on the conversion technologies suitable and if not suitable options for pre-treatment requirements needed to make it suitable for a certain technology.

2.3.2 Full chain assessments

In this part access is provided to 2 tools (still in development, so not included in GUI yet!):

BeWhere: This tool supports the development of EU-wide and national strategies to design and evaluate an optimal network of biomass delivery chains. The basis of this tool is a techno-economic spatial model that enables the optimal design and allocation of biomass delivery chains (at national level) based on the minimization of the cost and emissions of the full supply chain taking account economies of scale, in order to meet certain demand (as derived from WP 7). For doing this it considers the input on biomass cost-supply from WP 1, the conversion technology specifications of WP2 and the logistical and pre-treatment technologies from WP3 and the demand categories as assessed in WP7 with the ReSolve model (for different scenarios). ReSolve also takes into account the already existing production plants and local energy demand (provided the information is included in the tool). BeWhere provides as output a network of existing and suggestions for new biomass conversion and pre-treatment chains according to optimal selection of technology, their location and capacity, the costs of each segment of the supply chain, the total bio-energy and biomaterial demand (depending on which technologies can be feasibly included in the tool), avoided emissions at different geographical levels (regional, national and European level).

Overall it is clear that this tool can support the development of strategies for establishing biomass delivery chains to reach specific national bio-energy and wider bioeconomy targets. However, before enabling reliable support it is necessary to fill the tool with as accurate data on many aspects including biomass cost-supply, existing biomass installations, topography, road, railway and water network data, heat and power demand and cost/price. The tool will not be tested by all potential end-users after the production of the first version, but instead the results will be validated in three specific case studies. For these case studies best input data needs to be provided and then assessment runs need to be tested regionally and locally

with local experts. Once this is done the tool is ready to be used in regions to assess different strategies for development of local biomass delivery chain combinations. The tool will be finalised three months before the end of the project, but prototype versions will be ready in month 24. The assessment results produced with the tool will be used in WP8 for the development of the strategies in the specific case studies.

LOCAgistics: Local assessment tool for biomass delivery chains. This tool provides support to more regional and local stakeholders in making strategies for best ways to develop their bio-based economy and making use of sustainable local biomass resources potentially available to them. This tool relies heavily on data and will be developed for a number of regional case studies as it takes account of more local circumstances in terms of biomass supply, bio-physical environment and environmental sensitivities, legal arrangements, existing installations/factories and other infrastructure, grid access local heat, electricity and other non-energy demands for biomass. The scale of assessment is to be as detailed as data allows in the case studies for which the tool is developed. The tool is to be developed and validated for at least three case study regions which are going to be Burgundy, Finland, Spain (regions of Aragon and Extremadura) and The Netherlands.

This tool will support the user to design optimal biomass delivery chains particularly in high detail regarding the logistical networks at regional level and analyse in a comparative way (for different biomass delivery chain networks) the spatial implications and the environmental and economic performance. It will take account of the biomass cost-supply from WP1, the conversion and pre-treatment technology options from WP2 and WP3 and the novel logistical concepts of biomass hubs and yards from WP3. In relation to environmental impacts it takes account of the indicators and guidelines to be developed in WP5 for assessing the overall sustainability performance for bioeconomy value chains developed in WP5.

The tool will also contain a special biomass crop selection and allocation component which is particularly relevant for regions which have the possibility to develop the production of cropped biomass. It will support regions in developing the best strategies to come to a sustainable production of cropped biomass. This tool integrates crop environmental requirements, environmental impacts and environmental sensitivities (e.g. soil erosion, drought, nitrogen leaching sensitivity) in an LCA-GIS approach to come to an optimal allocation of innovative non-food cropping systems. This is then integrated with an economic (minimum acceptable return analysis) and logistics parameters (from WP3) to come to an optimal compromise between environmental and economic sustainability, while taking account of transport, pre-treatment and conversion feasibility.

The collection of data for the case studies is based on guidelines provided by WP4 in consultation with the case study partner and the data collection is done by case study

partners. Like with the BeWhere tool this LOCA tool also requires a validation of results in case study areas.

LOCAgistics and BeWhere are to be applied in an integrative manner in the project:

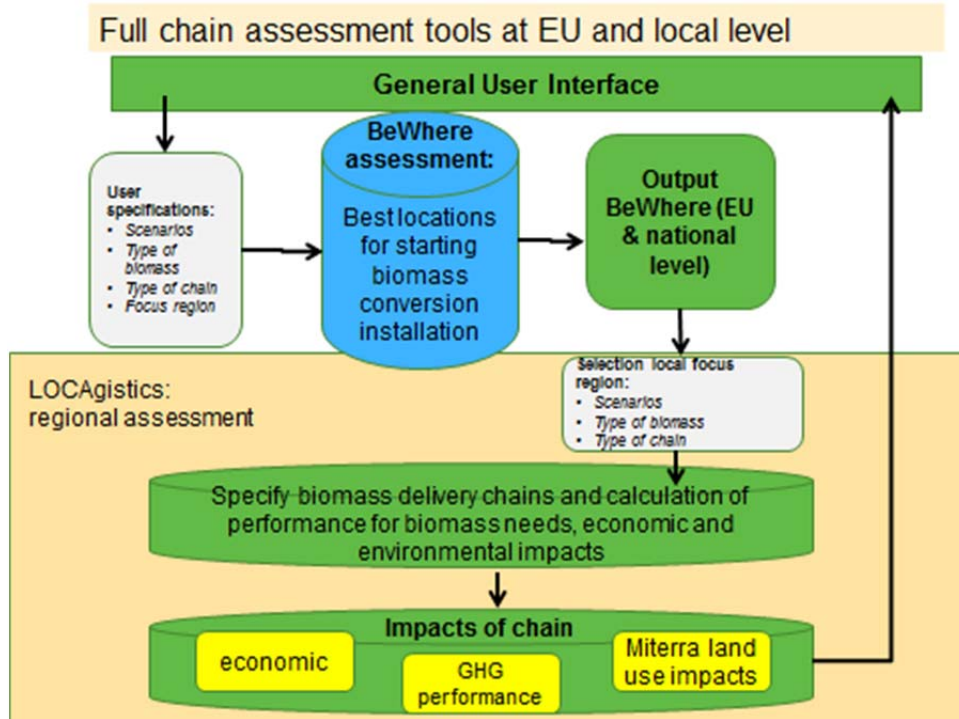

The BeWhere tool provides the first input into the LOCAgistics assessment by identifying the type of installation(s) in terms of technology, biomass demand, and size for which there is a demand and additional capacity in a region. For the technology and biomass combination the LOCAgistics tool then designs the detailed chain specifications given detailed spatially available biomass in the region. It then assesses the GHG emissions, mitigation potentials and economic performance of the full chain and of alternative chains varying around the BeWhere specifications of the chain. It also incorporates the (possible) land based impacts of the chains.

2.4 Strategies, roadmaps & implementation plans

This part of the GUI gives access to the guidelines, strategies, roadmaps and reports developed in the project in the different WPs in Theme 3 of the project for the case studies selected. For now it is foreseen to have the currently displayed items to structure the access to this material, but this structure may well be changed in the third year of the project.



Biomass chains

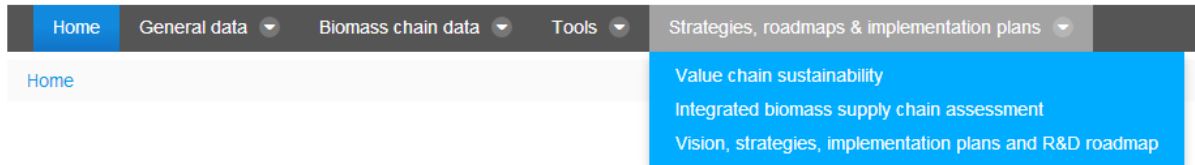

In principle all data, reports, strategies outcomes of interactive workshops should be included in the central database and made accessible and/or downloadable through the GUI.

3 Technical implementation of the GUI

The technical implementation of the tool is technically organised according to the scheme presented underneath.

Overview of tool, server and database links

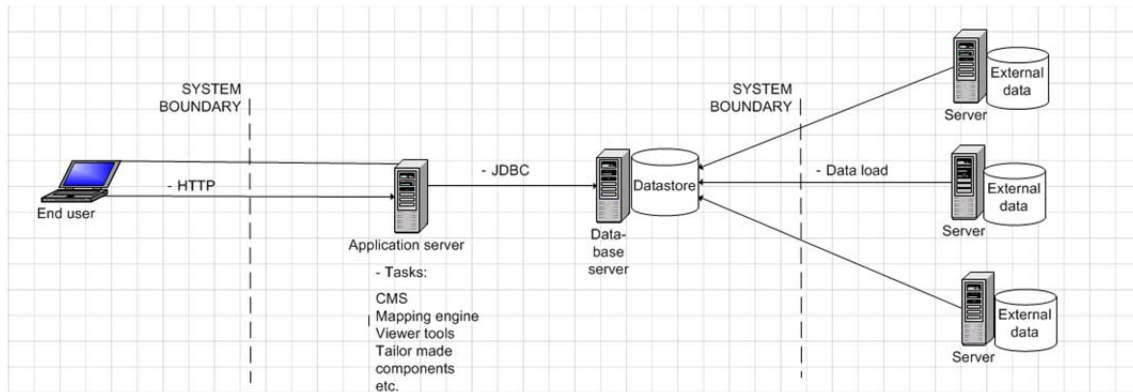

The tool is developed for a windows operating system.

The database containing all data generated by the project to be integrated into the tool is designed with PostgreSQL and PostGIS. The application server will run on Tomcat software. The CMS (Content Management System) will run on Liferay software. Finally the mapping software in the tool to be used is GeoServer.

For the full chain assessment tools and the biomass matching tools a large database will be developed with all possible combinations of (pre-cooked) assessments which will be presentable to the users according to their demand specifications. This solution is necessary to limit the running time of the tools. More complicated analysis requirements can be 'ordered' by the users of the tools and will be provided after some calculation time and/or model initiation input of the tool managers in the project.

